



LM-1 Digital Air/Fuel Ratio (Lambda) Meter Manual



The Oxygen Sensor used in this device gets very hot in operation. Do not touch the hot sensor. Do not let a hot sensor touch a combustible surface. Do not use the sensor with or near flammable liquids or gases. Failure to heed these warnings may result in severe burns, explosions or fires.

When installed in the exhaust, the oxygen sensor MUST be connected and operating with the LM-1 whenever the car is running. An un-powered oxygen sensor will be quickly damaged when exposed to hot exhaust gases.

1. Overview	3
2. The LM-1 Instrument	3
2.1. The LM-1 Instrument (Size: 7" x 4" x 1.5")	3
3. First Time Use	4
4. Installation.....	5
4.1 Mounting the sensor using a Bung or Exhaust Clamp.	5
4.2 How to fabricate a copper heat sink	6
5. Operation	7
6. Calibration	7
6.1 Free air calibration	7
6.2 Sensor heater calibration	8
6.3 Calibration Schedule	8
7. Recording other vehicle data with the LM-1	9
7.1 Overview	9
7.2 Recording.....	9
8. Remote display of Lambda and/or AFR	9
8.1 Analog Lambda/AFR instrument.....	9
8.2 Special considerations when installing LM-1 permanently in the vehicle.....	10
9. Programming the LM-1	11
9.1 Installing the LM Programmer Software	11
9.2 Hooking up the LM-1 device to the computer.....	11
9.3 Resetting the calibration data	12
9.4 Updating the software (LM-1 firmware)	12
9.5 Changing the sensor type.....	13
9.6 Programming the analog outputs.....	14
9.6.1 Advanced output programming.....	15
10. Tips, Tricks and Troubleshooting	16
10.1 General measurement requirements.....	16
10.2 Vehicles with 'smog-pumps'	16
10.3 Measuring at the tail-pipe	16
10.4 Single Cylinder Engines.....	16
10.5 Diesel Engines	16
10.5 Reference cell or Pump cell circuit open or shorted errors	16
10.6 Sensor Timing Errors	17
10.7 Other tricks.....	17
10.8 Calibration tricks and hints.....	17
10.8 Analog Output tricks/hints.....	18
11 Advanced Topics	18
11.1 Connecting the LM-1 to simulate a narrow band oxygen sensor.....	18
Appendix A: LM-1 Cable Pinouts	19
Appendix B: LM-1 Error Codes and Troubleshooting Tips	22
Appendix C: Limited Warranty.....	23
Revision History.....	24

1. Overview

The LM-1 is a hand-held instrument used to measure the Air/Fuel Ratio (AFR) or Lambda for an engine. For *gasoline*-driven engines, the theoretically optimal air fuel ratio is 14.7 pounds of air for every pound of fuel. At this ratio, theoretically, all available oxygen in the air combines with all available fuel. This ratio is called the stoichiometric ratio. Stoichiometric for different fuels are as follows:

Gasoline	14.7
LPG (Propane)	15.5
Methanol	6.4
Ethanol	9.0
CNG	17.2
Diesel	14.6

The measurement Lambda is the actual air fuel ratio over the stoichiometric ratio. A Lambda measurement of "1" equates to the air fuel ratio of 14.7 (for gasoline engines). When Lambda is less than 1 the engine runs "rich", i.e., unburned fuel exists in the exhaust stream. If lambda is greater than 1 the engine runs lean, i.e., free oxygen (O^2) is present in the exhaust. Depending on the engine, maximum power is typically delivered when the engine runs slightly rich (for example at lambda values of 0.8 to 0.9 for most engines). This instrument provides a means to measure the actual air fuel ratio or lambda in the engine in operation directly from the exhaust. For this a special wide-band oxygen sensor is used to measure the lambda value derived from the oxygen content (or lack thereof) of the exhaust gases.

2. The LM-1 Instrument

The LM-1 set contains the following parts:

2.1. The LM-1 Instrument (Size: 7" x 4" x 1.5")



3. First Time Use

1. Verify that the included 9V battery is installed in the battery compartment on the bottom of the instrument.
2. Connect the power cable to the LM-1 12V Power connector and plug the other end in your cigarette lighter socket in your car. Note that the 9V battery is for powering the LM-1 electronics and display, but it cannot power the oxygen sensor. (The primary purpose for the 9V battery is to power the LM-1 when it is connected to a PC for data downloads). You must have a 12V power supply available to power the oxygen sensor.
Note: The supply voltage to the LM-1 must not exceed 16V.

3. Do not connect the sensor yet.

4. Switch the meter on.

The display shows either:

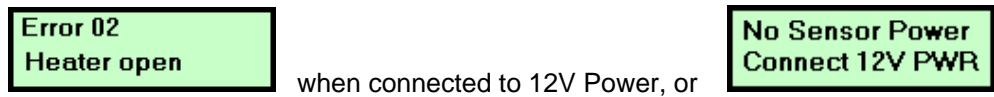

In the second case, switch the ignition of your car on.

5. Switch the meter off after 10 seconds.
6. Connect the sensor to the sensor interface connector. The sensor must be exposed to air for the first time calibration.
7. Switch the meter on. The display should show now:

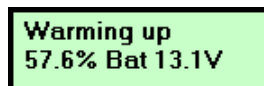

Indicating that the sensor is warming up to its optimum operating temperature. The display shows what percentage of the temperature is reached and what the battery voltage is that the meter sees on the power connector. The warm-up period will last for about 30 seconds for a cold sensor, depending on the sensor type used.

After the sensor is warmed up the meter automatically calibrates the sensor heater controller to the particular sensor. During this 20-second period the LM-1 collects and calculates sensor specific data required to quickly reach operating temperature in the future. After the first time use the meter will use these values to regulate the sensor's temperature. During the heater calibration the display will show:

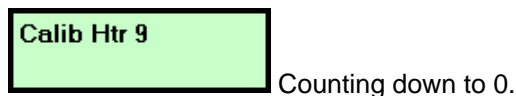

Note: When using the Bosch Sensors the LM-1 may perform multiple calibration passes. This is normal and need not cause concern. When it completes, continue to step 8.

8. Press the Calibration button.

The meter will now calibrate itself by using air as a reference gas with known oxygen content. After the calibration period is over (2-3 seconds), the instrument is ready to operate.



To recalibrate you need to hold down the Calibration button for a minimum of 2 seconds.

4. Installation

4.1 Mounting the sensor using a Bung or Exhaust Clamp.

Using a bung is the preferred method for mounting the O² sensor for both catalytic and non-catalytic cars.

On CATALYTIC CONVERTER equipped vehicles:

Bung: Install the oxygen sensor's bung upstream from the catalytic converter (a bung and plug is included in the LM-1 kit). Any decent muffler or exhaust shop can do this for you. The wide-band oxygen sensor is then installed into the bung to take a reading. (Insert the plug into the bung when not in use). **The bung must be installed in the exhaust pipe at the side or on top, NOT on the bottom of the exhaust pipe.** Best position is between 10:00 and 2:00 position.

.....*or*.....

Exhaust Clamp: You *may* use the optional Exhaust Clamp to mount the O² sensor to the car's tail pipe when taking readings from cars with catalytic converters (see below). However, it is recommended instead to use the bung (as described above) to give you the most accurate reading. Measuring after the cat will result in leaner-than-reality readings, depending on the efficiency of the cat. Some operators of chassis dynos use this method and roughly "correct" the reading.

On NON-CATALYTIC converter vehicles:

Exhaust Clamp: With non-cat cars, you can simply take the reading from the car's tail pipe; however, you **MUST** use the optional Exhaust Clamp to do so. **Do NOT simply insert the O² sensor into the tail pipe.** Doing so may damage the sensor and it will certainly not yield accurate measurements. (The oxygen sensor needs to have its cable exposed to outside air to yield the most accurate results.)

.....*or*.....

Bung: You have the option with non-catalytic cars to also use a Bung as described above. Use of a bung is the preferred method for mounting the O² sensor for both catalytic and non-catalytic cars.

On TURBO CHARGED vehicles:

Bung: Install the bung downstream from the turbo before the catalytic converter. The high exhaust pressure before the turbo interferes with the lambda measurement and the high exhaust temperatures encountered there can damage the sensor.



Do NOT install the Bung below the 3 o'clock or 9 o'clock position. Condensation can form in the exhaust pipe and permanently damage the sensor. 6 o'clock is the absolute worst position to mount the sensor.



Wide band oxygen sensors – like the one shipped with the LM-1 – are designed to work with unleaded gasoline. Using them with leaded gasoline will significantly reduce the lifespan of the sensor. The reduction is directly proportional to the metal content of the fuel. In most cases, a wide band sensor will provide accurate measurements somewhere between 50 hours and 500 hours with leaded fuel.



WHEN INSTALLED IN THE EXHAUST, THE OXYGEN SENSOR MUST BE CONNECTED AND OPERATING WITH THE LM-1 WHENEVER THE CAR IS RUNNING. AN UN-POWERED OXYGEN SENSOR WILL BE DAMAGED WHEN EXPOSED TO EXHAUST GAS.

RULE OF THUMB: POWER UP THE OXYGEN SENSOR IMMEDIATELY AFTER THE ENGINE IS STARTED. (See Section 8.2)



The maximum temperature of the sensor at the bung (the sensor hexagon) should not exceed 500 °C or 900 °F. If these temperatures are exceeded in your application you should either install a copper heat sink (instructions below) or the Innovate Motorsports Heat-Sink Bung extender (HBX-1). The bung extender is recommended for situations where airflow is restricted or the encountered heat is higher than a heat sink can handle.

4.2 How to fabricate a copper heat sink

Use a 4" x 4" (10cm x 10 cm) sheet of copper sheet metal 14ga (1.5mm) thick. Drill a hole in the center with the same diameter of the oxygen sensor threads ~3/4" (19mm). Fold the sides up 45 deg and mount it between the sensor and the bung like you would a big washer. Orient it such that the sides are exposed to good airflow.

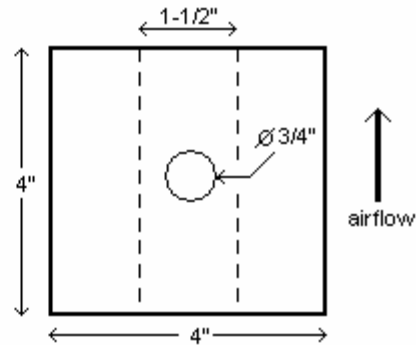
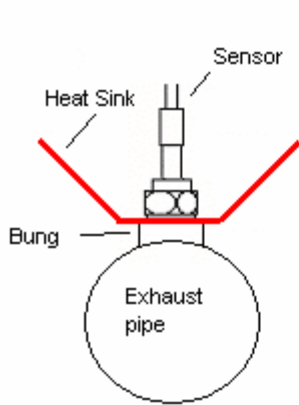

5. Operation

Once the LM-1 has been installed and is in place (see Chapter 4: Installation), lambda measurements can now be taken.

In operation, the meter's display shows:

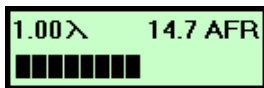

showing both the current lambda value and air-fuel-ratio. The numeric lambda and air-fuel-ratio values are averaged over about 0.2-0.3 seconds so that the numbers are more consistent and easy to read.

If lambda is greater than 6 (for example, in free air), the display will show “—” for Lambda, and instead of an AFR reading, the percent of oxygen will be shown..

The bar-graph at the bottom shows the actual instant lambda value in 16 steps. The more of the bar showing, the richer the mixture. The bar at mid-level means a lambda value of 1.0 (AFR of 14.7 for gasoline engines). If the whole bar shows, the actual lambda value is 0.68 or richer (AFR of 10 or less for gasoline engines). If none of the bar shows the lambda value is 1.32 or leaner (AFR 19.4 or more for gasoline engines).

6 Calibration

There are two types of calibration for the LM-1: free air calibration and sensor heater calibration. Sensor heater calibration is automatically performed the first time a new sensor is used, while free air calibration should be executed frequently.

6.1 Free air calibration

To achieve maximum precision, the LM-1 and its sensor needs to be recalibrated frequently. When the measured lambda is greater than 6, the display will show the oxygen content in %. For free air it should show 20.9%. If the display value is different by more than 0.6%, recalibrate. You can test the oxygen sensor by breathing on it. The oxygen content of your breath will show.

The sensor MUST be operated in free air for calibration.

If the wide-band sensor is installed in a vehicle, wait 6-8 hours after running the engine so that all exhaust gas is dissipated from the exhaust tract of the vehicle. Better yet, disengage the oxygen sensor and expose the sensor to air (away from the exhaust) for calibration purposes:

1. Connect the meter to 12V from the vehicle and switch it on.
2. After the sensor has warmed up, press the '**Calibrate**' button for a minimum of 2 seconds.
3. After the calibration is complete, switch the LM-1 off and wait for 30 seconds before you start the car.

The display will show "Free Air Calibr." while it calibrates itself. When the calibration procedure is finished (2-3 seconds), the display returns to normal showing lambda and oxygen content. If the oxygen content now differs from 20.9% by more than 0.6%, repeat the calibration.

6.2 Sensor heater calibration

If you change the sensor – either with a replacement sensor or a new type of sensor --, the heater circuit of the LM-1 needs to be recalibrated as well. (See steps in chapter 3 'First Time Use'). The heater calibration data in the LM-1 will be reset when the meter is operated from 12V without a sensor connected for at least 5 seconds. You can force a reset by doing this, and then recalibrate by turning the unit off, reconnecting the sensor, and turning the unit on.

After the sensor is warmed up the meter automatically calibrates the sensor heater controller to the particular sensor. During this 20-second period the LM-1 collects and calculates sensor-specific data required to quickly reach operating temperature in the future. During the heater calibration the display will show:

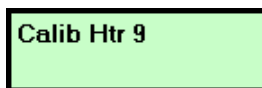

Counting down to 0.

Note: When using the Bosch Sensors the LM-1 may perform multiple calibration passes. This is normal and need not cause concern. When it completes, continue to a free air calibration. **It is recommended to perform a free air calibration after any time the sensor heater is recalibrated.**

6.3 Calibration Schedule

Normally aspirated daily driver:

- Calibrate before installation of new sensor
- Calibrate new sensor again after 3 month of use
- Thereafter calibrate once a year or every 20,000 miles, whichever comes first

Turbo car, daily driver (tuned rich):

- Calibrate before installation of new sensor
- Calibrate new sensor again after 3 month of use
- Thereafter calibrate twice a year or every 10,000 miles, whichever comes first

Race car

- Calibrate before first installation of new sensor
- Calibrate once per race weekend

Dyno use

- Calibrate a new sensor
- Calibrate every 2-3 days, depending on usage

7. Recording other vehicle data with the LM-1

7.1 Overview

The LM-1 has the capability to record other vehicle data from other vehicle sensors while driving so as to compile a complete log of engine data. For example, the optional LMA-2 cable provides input for up to 5 other sensors (RPM plus 4 others) to the LM-1 whose data values will be recorded.



Never connect the Aux inputs to 12 volt or battery power. Connecting the inputs to sources that generate greater than 5 volts will result in damage to the LM-1.

The LM-1 simply records the voltage on each input connection with a resolution of 10 bits (a precision of 0.00488 Volt). LM-1 will record up to 44 minutes of data from all sensors including lambda. A new value for each sensor is recorded every 0.08192 seconds (roughly 12 times/second). Software to view and analyze recorded data log files is included with your LM-1 and can also be downloaded at www.tuneyourengine.com.

7.2 Recording

To record data in the LM-1, press the **'Record'** button. The LM-1 will display a blinking 'R' between the lambda and AFR/O2 measurements while recording. To stop recording, press the **'Record'** button again. Each time you start recording a new record 'Session' is created. A total of 44 minutes of data can be recorded in the LM-1. If the internal memory of the LM-1 is full, the blinking 'R' will not show when starting a recording session. Instead it will show an 'F' for 'Full' for a few seconds. To erase all recorded data, press and hold the **'Record'** until 'RS' (for **ReSet**) shows between lambda and AFR/O2 display.

Use the included LogWorks software package to download recorded data.

8. Remote display of Lambda and/or AFR

In some applications it may be desirable to mount the LM-1 in the engine compartment or under the dash permanently and monitor the air-fuel data remotely using a dash-mounted instrument. The LM-1 provides two options for that application.

8.1 Analog Lambda/AFR instrument.

There are many analog lambda/AFR displays on the market. They are essentially voltmeters for a voltage between 0 and 1 V and measure the analog voltage of a narrow band oxygen sensor. Some are true analog instruments while others provide a LED bar. Because of the very limited sensing range of a narrow band sensor they are essentially useless as true AFR meters. With the LM-1, connecting these meters to the second analog output of the LM-1 allows them to be used as true remote AFR meters, provided the LM-1 analog output is programmed to the characteristics of the used meter. (Note: the LM-1's Analog Out port is a mini-TRS (stereo) connection which provides two analog outputs, plus a ground.) The LM-1's second analog output is factory programmed to provide a linear output between 1V and 2V for an AFR of 10 to 20, allowing a digital voltmeter to be used as the AFR display. Any other linear output range between 0 and 5V can be programmed. See chapter 9.6, 'Programming analog outputs' for details.

8.2 Special considerations when installing LM-1 permanently in the vehicle



Do NOT install the 9V battery in the LM-1 when installing it permanently in the vehicle.

In a typical permanent installation the LM-1 will be powered by switched 12V from the vehicle (12V switched on when the ignition key is turned on) while its power switch is permanently on. Because the LM-1 automatically switches to internal battery power when it does not detect 12V, the internal battery would drain quickly while the vehicle is parked. To avoid this, do not install the 9V battery. The LM-1 will function correctly without it and will be able to record as usual. To download recorded data, follow the alternate steps described in chapter 9.

It is NOT a good idea to connect the LM-1 permanently to 12V and switch it on before the vehicle is started. Depending on the climate and the sensor position in the exhaust, condensation water can form in the exhaust pipes. This condensation water could then be blown by the exhaust stream against the hot sensor when the car is started. The resulting heat shock can permanently damage the sensor.

To protect the LM-1 when installed permanently it is a good idea to **power the LM-1 only after the car is started**. The starter motor in some vehicles can create voltage spikes of over 100V that have the potential to do damage. Although rare, this is a real possibility and the LM-1 contains protection circuitry to guard against it. A relay connected as shown below insures that the LM-1 is disconnected while cranking. This reduces further drain on the car battery by the sensor heater and protects the LM-1 against abnormally large voltage spikes.

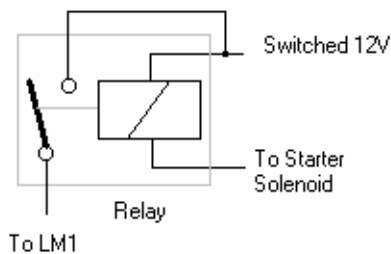

Connect one terminal of the relay switch and relay coil to switched 12V (number 15 on European cars). Connect the other switch terminal to the 12V input of the LM-1. Connect the other end of the relay coil to the starter solenoid wire (number 50 on European cars). When the starter solenoid is operated, the relay will switch off. In running condition, the relay coil current will flow from 12V through the starter solenoid to ground. The relay coil current is normally far too small to operate the starter solenoid.

9. Programming the LM-1

The LM-1 is programmable with the following functionality:

1. Change the relationship between Lambda and AFR.
2. Upgrade and change the software.
3. Switch between sensor types.
4. Change the output characteristics of the Analog outputs.
5. Download recorded data into a spreadsheet.
6. Graph and analyze the recorded data.

9.1 Installing the LM Programmer Software

Put the included CD in your CD-drive on your computer and follow the instructions on screen. The LM-1 Software will be installed including pre-set directories for log-data and downloaded software. The LM-1 Installer also puts entries for the LM-1 Software in the Start-Menu of your computer under the heading 'Innovate!'.

The following items will be installed on your hard-drive

1. LM1 Programmer
This is used to program the analog outputs of the LM-1, the fuel type used, the sensor type used, and also allows to 'reflash' the firmware of the LM-1.
2. LogWorks
This is a comprehensive datalogging and analysis package to download and analyze engine data recorded by the LM-1. It also allows real-time logging and display.
3. This manual (LM-1 Manual)
4. The LogWorks Manual
Describes how to use LogWorks for datalogging and engine analysis.
5. The RPM converter (LMA-2) Manual
Describes how to operate and use the LMA-2 RPM converter and how to connect different engine sensors.
6. The current firmware for the LM-1
7. An example datalog file

9.2 Hooking up the LM-1 device to the computer

- Connect the included serial download cable to a free serial port on your computer.
- With the LM-1 turned off, connect the round Mini-DIN8 connector to the serial port of the LM-1.
- Start the LM Programmer
- Switch on the LM-1 Instrument.

The LM-1 display shows:

Serial Interface

The LM-1 will stay in serial mode until it is switched off, either by its power switch or by disconnecting 12V if no internal battery is installed.

Your screen should look like this:



On this page you can see the software version of the LM-1, which sensor your LM-1 uses and you can change the multiplier to calculate AFR from Lambda. A number of different multipliers are already pre-selectable but you can change it to a custom one for the particular fuel you are using.

9.3 Resetting the calibration data

Press the Reset Calibration button if you want to reset all calibration data in the LM-1. This will clear all calibration data of the LM-1.

9.4 Updating the software (LM-1 firmware)

Click the 'Update Firmware' in the main page to upgrade to the latest *firmware* for the LM-1. Firmware for the LM-1 has the extension dld. You can also download the latest firmware and software (LM Programmer and Demo) from the Innovate! Motorsports web-site at

<http://www.tuneyouengine.com>

If your computer crashes during a firmware upgrade, the LM-1 has a recovery mechanism where it will be able to retry the download again and not be disabled by half loaded firmware. Switch the LM-1 off and on again and then try to restart the LM1 Manager software. The recovery mechanism is designed to be able to recover 99.9% of the time. While we don't anticipate this occurring, it is possible that the LM-1 will not recover correctly and may need to be serviced at our factory. If you suspect this is the case, contact Innovate support.

9.5 Changing the sensor type

The LM-1 device is compatible with the following sensors:

Device Name	OEM Part Number
Bosch LSU 4.2	0 258 007 057/058
Bosch LSU 4	0 258 006 066
NTK L1H1	L1H1

To switch a LM-1 to a different sensor type, follow these steps:

1. Select the sensor type to use in the Info/Set AFR Tab of the LM1 Manager and let the LM1 Manager download the appropriate software into the LM-1
2. Disconnect all cables from the LM-1 and remove the 9V battery.
3. Open the LM-1 housing by removing the 4 screws holding the housing bottom to the housing top.
4. Carefully separate the two housing parts. Be careful not to stretch and break the battery cable.
5. On the main circuit board in the top housing part, locate the 8 pin sensor selection header.
6. Move the jumper to the appropriate position for your new sensor. See picture below.

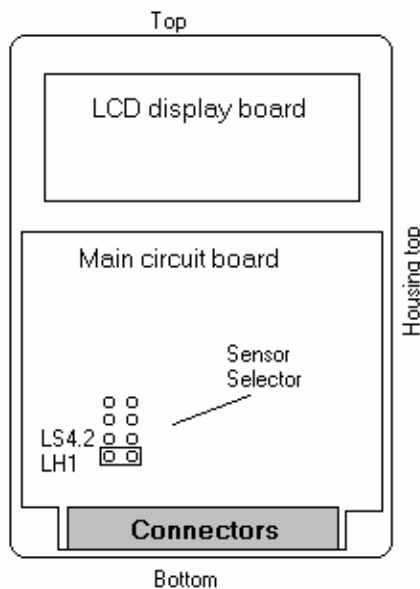

The jumper in this picture is shown installed for the NTK L1H1 sensor.
The second position from the bottom is for the BOSCH LSU4.2 and LSU 4 sensor.
The remaining two positions are reserved for future sensors.

7. Reassemble the LM-1, reinstall all cables and the 9V battery if desired.
8. Follow the steps in Chapter 3: First Time Use.

9.6 Programming the analog outputs

Select one of the Analog output tabs. The Analog output page looks like this:

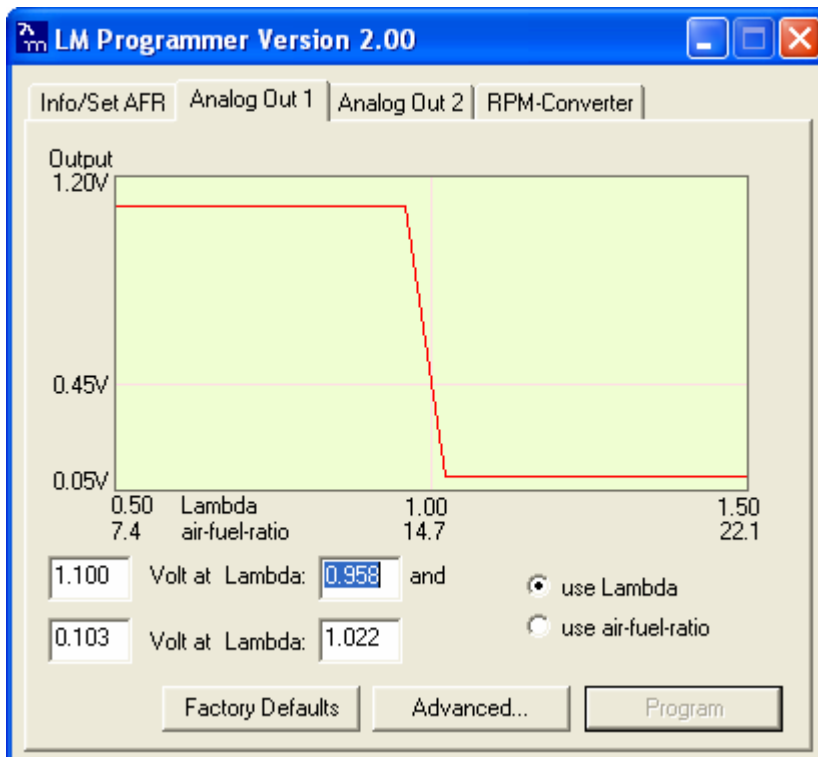

This shows the analog output voltages versus Lambda for one of the two analog outputs. The graph display is automatically scaled to the selected voltages. For each output you can specify a minimum and maximum lambda value and the associated voltages. Below the minimum and above the maximum lambda values the output voltages stay constant at the associated programmed voltage.

By selecting the 'use Air-Fuel-Ratio' button you can program the curve by AFR instead of Lambda.

This does not change the programming, only the representation of the data. When programming by AFR the LM Programmer converts the number to Lambda before programming the LM-1.

Click the Program button to download the new data into the LM-1.

As factory programmed the first output simulates a typical narrow band oxygen sensor. The second output is programmed to output between 1.0 V for an AFR of 10 (gasoline) and 2.0V for an AFR of 20. This allows to connect it to a digital voltmeter or panel meter (0.2V input) to show directly AFR. Other curves of course are easily programmable

9.6.1 Advanced output programming

Note:

The advanced analog output settings are only available from LM-1 firmware version 1.33b on. If your LM-1 has an earlier version of firmware, you can upgrade to later versions by downloading it from www.tuneyouengine.com.

The normal state of the analog outputs is to update the outputs every time the LM-1 takes a new measurement. The LM-1 is fast enough to distinguish individual pockets of exhaust gas. For many applications this will be too fast. The advanced programming allows to set the analog out update speed.

Press the “Advanced button” to set the advanced analog out settings. The following dialog box will appear:

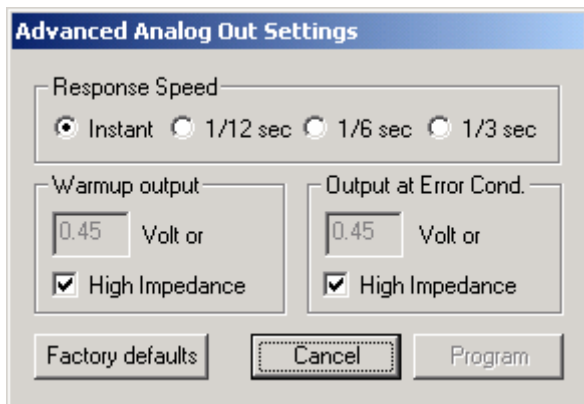

When setting the LM-1 to the slower response speed settings the measured mixture data will be averaged over the response time setting before being output.

You can also specify what output voltage is visible on the analog outputs during warmup of the sensor and during error conditions.

The ‘High Impedance’ setting allows to specify that the analog outputs do not drive the output during warmup or error condition. They will be free floating. This is important for more closely simulating a narrow band sensor. Many EFI systems monitor the impedance of a narrow band sensor during engine warmup to determine sensor readiness. A narrow band sensor that’s too cold will have a high impedance.

Note:

The high impedance setting will always apply to both analog outputs of the LM-1. They can’t be set to high impedance individually.

10. Tips, Tricks and Troubleshooting

10.1 General measurement requirements

The LM-1 measures the air-fuel-ratio by measuring the amount of oxygen in the exhaust (for lean conditions) or the amount of unburned or partially burned fuel (for rich conditions). You should correct for the following in order to get optimum results from the LM-1

- 1) An exhaust leak will allow oxygen to enter the exhaust stream and therefore will measure leaner than the engine is actually running. For correct measurement, air-leaks in the exhaust **MUST** be prevented under all circumstances.
- 2) Missing ignitions (where the air-fuel mixture does not ignite) also pump unburned oxygen into the exhaust and cause the LM-1 to measure lean.
- 3) The only circumstance where the LM-1 will measure richer than the engine is running is if the pressure in the exhaust tract is excessive (and the engine is running on the rich side to begin with).

10.2 Vehicles with 'smog-pumps'

Older fuel injected vehicles with a 'smog-pump' actually inject air into the exhaust stream to aid their catalytic converter in the burn-up of unburned or partially burned fuels. This additional air will make the exhaust look leaner than the engine is running. For an accurate measure, install the LM-1 sensor up-stream of the outputs of the smog-pump. If this is not possible, temporarily disable the smog-pump by removing its drive belt.

10.3 Measuring at the tail-pipe

On non-catalytic converter equipped vehicles it is possible to measure the air-fuel-ratio at the tail-pipe. It is highly recommended to use the optional LM-1 Exhaust Clamp. Without it too much outside air may enter the exhaust, especially at idle, to prevent correct measurements and leading to a lean measurement. Sticking the sensor itself into the exhaust pipe can yield inconsistent results because the sensor will not have outside air available as a reference gas and its reaction time becomes so slow that the LM-1 will report a sensor timing error. The oxygen sensor needs to have the back part of the sensor (where the wires enter the sensor) exposed to outside air.

10.4 Single Cylinder Engines

These kinds of engines are difficult to measure at the tail-pipe. The oscillations of the exhaust gas are so large that a lot of outside air enters the exhaust and prevents correct measurement. Sometimes it helps to just wrap a piece of heat resistant cloth around the exhaust clamp to prevent outside air from entering the exhaust.

10.5 Diesel Engines

Diesel Engines and gas turbines run at wide open throttle at all times. They do not have a throttle but regulate power by the amount of injected fuel. The LM-1 can still be used, but measurements at idle will read as lean.

10.5 Reference cell or Pump cell circuit open or shorted errors

Under some rare circumstances it is possible that the heater calibration data in the LM-1 can become partially destroyed. This can manifest in the above-mentioned errors. Follow the steps in chapter 3 'First time use' to reset the heater calibration data.

10.6 Sensor Timing Errors

These errors are typically encountered when the sensor does not have outside air available as reference gas. If you encounter this error, restart the LM-1 and operate the sensor in free air. If you still encounter this error, the sensor may be bad and needs to be replaced.

Replacement sensors are available from your nearest VW dealer under the VW part-number 021-906-262-B or direct from Innovate Motorsports.

Sensor timing errors are also common when the sensor overheats. Relocate the sensor further downstream in the exhaust, install a heat sink or Heat-Sink Bung extender (HBX-1).

Sometimes it's possible to encounter Error 08 when the exhaust gas suddenly gets too rich. Normally the LM-1 will display a 'too rich' indication if the exhaust gas is too rich. If the mixture gets rich very suddenly, the LM-1 cannot distinguish between a too rich condition and a sensor timing error.

10.7 Other tricks

The LM-1 has two different functions for the record and calibration button when it runs off it's internal 9V battery (12V disconnected):

1. Calibration button:

Shows firmware version and sensor type used.

2. Record button

Pressing the record button with an RPM converter connected shows the RPMs read by the RPM converter.

Note:

If the RPM converter is programmed for RPMs greater than 10230 (see RPM converter manual), the shown RPM's will be $\frac{1}{2}$ of the real RPMs.

10.8 Calibration tricks and hints

If the outside air-pressure changes dramatically (for example from sea-level to 10 000 ft) the sensor calibration will be off. Recalibrate the LM-1 at the new altitude and then tune your engine to the same AFR as on sea level. This insures the same AFR as determined at the different altitude is used by the engine to maximize performance.

Note: The following tricks can only be performed on EFI equipped engines, not carbureted or CIS engines.

Sometimes it is inconvenient to remove the sensor from the exhaust pipe for recalibration. On EFI equipped vehicles the following trick can be used:

EFI systems usually shut the injectors off during coast-down conditions (throttle closed and RPM typically greater than 1500 RPM). In this situation the engine just acts as a car-driven air-pump and fills the exhaust system quickly with pure air. In this situation the sensor can be recalibrated. If you need to step on the throttle while a calibration is in progress, you **MUST** repeat the calibration.

To quickly clear out remaining exhaust gas from the exhaust tract, it also helps to rev the car up in neutral, then at high RPMs shut the engine off while holding the throttle fully open. While the engine rotates to a stop it will act as air-pump. Holding the throttle fully open (WOT) minimizes pumping losses and allows the engine to pump a maximum of air without the need to suck it past the throttle plate.

10.8 Analog Output tricks/hints

Very often there is a ground offset between the device that receives the analog output voltage and the LM-1. Both devices reference different grounds and therefore see different voltages. So to compensate for the ground offsets the analog output voltage points have to be shifted by the ground offsets. To measure what the real ground offset is, you can program the analog outputs temporarily to output a flat line voltage by entering the same voltage in both fields for the two analog out programming points. This way the analog output voltage will be fixed, independent of current AFR and can therefore be measured and compensated for easily



Note:

The analog outputs are NOT designed to power other devices or sensors. So using the flat-line setting at 5V and expecting to power a sensor from it will not work and can damage the LM-1.

11 Advanced Topics

11.1 Connecting the LM-1 to simulate a narrow band oxygen sensor.

It is possible to install the wide-band sensor in place of the OEM oxygen sensor. In this case the meter's analog output signal will replace the OEM oxygen sensor's signal to the fuel injection computer. EFI equipped cars typically incorporate a narrow band oxygen sensor. These sensors are typically 1, 2, 3 or 4 wire sensors.

The analog output connector of the LM-1 can simulate the operation of a narrow band sensor while the wide-band oxygen sensor is installed in place of the OEM narrow-band sensor. Factory equipped Analog output 1 of the LM-1 is programmed to simulate a narrow band sensor. Some vehicles are equipped with oxygen sensors that do not produce an output voltage but change their resistance depending on exhaust gas content. These sensors **cannot** be simulated. They are used in less than 1% of all vehicles. Refer to your vehicles specifications if you think that your vehicle may be in this category. The same is true for vehicles already factory equipped with a wide-band oxygen sensor. These **cannot** be simulated either.

Some EFI-computers will create a fault when the heater power wires of the oxygen sensor are disconnected. In this case mount the old oxygen sensor in a safe place (but not necessarily in the exhaust) and connect the heater wires to it to keep the EFI-computer happy.



Be careful where you mount the stock sensor, as heated sensors will get hot.

To connect the LM-1 to the EFI-computer, first determine what kind of narrow band sensor is used, then follow the instructions below (you will need a digital multimeter to determine correct OEM sensor wires):

a. Vehicle has a 1-wire sensor:

Wire analog output 1 directly to the wire.

b. Vehicle has a 2-wire sensor:

While the engine is off determine which of the 2 wires has a low resistance between the wire and the sensor body. This is the heater power for the sensor. Wire analog output 1 directly to the other wire. Leave the heater power wire unconnected but make sure it cannot ground itself or see above.

c. Vehicle has a 3-wire sensor:

Typically the 3 wires are: heater power, Ground, and sensor element connection. Generally they have 1 black wire and 2 white wires. Connect the black wire from the EFI computer to analog output 1 of the meter. Leave the other wires unconnected but make sure they cannot contact any metal parts or see above. If the wiring colors are different, then heater power can simply be determined by measuring the voltage on the wires when the engine is running. The wire showing 12V or more is the heater power. The sensor element connection voltage fluctuates around 0.45V when the car is warmed up. Wire analog output 1 directly to this wire. The Ground connection has low resistance to chassis ground (less than 1 Ohm). Measure while the engine is off.

d. Vehicle has a 4-wire sensor

Typically the 4 wires are: heater power, heater ground, sensor ground, and sensor element connection. Proceed as for the 3-wire sensor.

Appendix A: LM-1 Cable Pinouts

A1. Serial Interface (Mini-DIN8 female connector)

Serial Interface:

19.2 kBaud
8 Data bits
1 Stop bit
no parity
no hardware handshaking

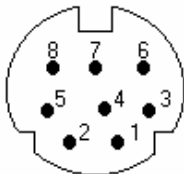

Pin Assignments

Lambda Meter

Mini-DIN8	Signal	Computer DB-9	Computer DB-25	
1	n/c	n/c	n/c	
2	CTS	8	5	Connected to +5V
3	RxD	2	3	
4	GND	5	7	
5	TxD	3	2	
6	GND	5	7	
7	n/c	n/c	n/c	
8	n/c	n/c	n/c	

A2. Aux Input Connector (Mini-DIN7 female connector)

Note: Connect to signal of maximum 5V only.

Serious damage to meter and/or sensor may result if connected to signals of more than 5V amplitude.

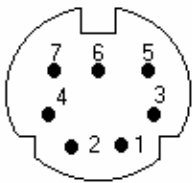

Pin Assignments

Lambda Meter

Mini-DIN7	Signal
1	+5V from Meter
2	Sensor 5 Input
3	Sensor 1 Input
4	Sensor 4 Input
5	Sensor 2 Input
6	Sensor 3 Input
7	Ground

A3. Analog Outputs (3.5mm Stereo connector)

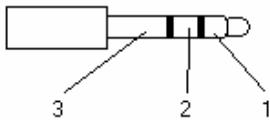

Stereo plug shown

Pin Assignments

Lambda Meter

Stereo	Signal
1	Analog output 1
2	Analog output 2
3	Ground

A4. Sensor Interface Connector (Standard DIN-5 female)

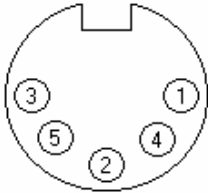

Pin Assignments

Lambda Meter	Signal	Wire Colors Bosch LSU4.2	Wire Colors NTK L1H1
1	Pump+	red	white
2	Sens+	black	red
3	Heater -	white	yellow
4	Pump-/Sens-	yellow	black
5	Heater +	gray	orange

A5. Power Connector (3.5mm power connector female)

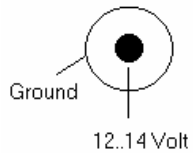

Appendix B: LM-1 Error Codes and Troubleshooting Tips

Error Code	Error Message	Likely Root Cause	Fix
Error 1	Heater circuit shorted	<ol style="list-style-type: none"> 1. Short in cable 2. Short in sensor 	<ol style="list-style-type: none"> 1. Repair/replace cable. 2. Replace sensor.
Error 2	Heater circuit open	<ol style="list-style-type: none"> 1. Damaged cable or DIN connector not fully seated 	<ol style="list-style-type: none"> 1. Verify DIN connector is fully seated into unit. Repair/replace cable.
Error 3	Pump cell circuit shorted	<ol style="list-style-type: none"> 1. Short in cable 2. Short in sensor 3. Sensor heater calibration incorrect 4. Sensor overheating 5. EGT >1700° F 	<ol style="list-style-type: none"> 1. Repair/replace cable. 2. Replace sensor. 3. Perform sensor heater recalibration. 4. Move your sensor bung as far downstream as possible OR add a heatsink to isolate the sensor from the pipe. 5. ""
Error 4	Pump cell circuit open	<ol style="list-style-type: none"> 1. Damaged cable or DIN connector not fully seated 2. Sensor heater calibration incorrect 	<ol style="list-style-type: none"> 1. Verify DIN connector is fully seated into unit. Repair/replace cable. 2. Perform complete heater calibration (not just free air calibration). See section 4.6
Error 5	Reference cell circuit shorted	<ol style="list-style-type: none"> 1. Short in cable 2. Short in sensor 	<ol style="list-style-type: none"> 1. Repair/replace cable. 2. Replace sensor.
Error 6	Reference cell circuit open	<ol style="list-style-type: none"> 1. Damaged cable or DIN connector not fully seated 2. Damaged Sensor 	<ol style="list-style-type: none"> 1. Verify DIN connector is fully seated into unit. Repair/replace cable. 2. Replace sensor
Error 7	General System error (typically a software error).	Typically a software error	Reboot LM-1. Re-flash unit if necessary.
Error 8	Sensor Timing error (typically a damaged sensor).	<ol style="list-style-type: none"> 1. Sensor overheating. (The Bosch LSU4.2 is rated to operate at a sensor housing temperature of < 900 degrees (measured at the bung) for maximum accuracy and control. When this operating temperature range is exceeded, the sensor can no longer be accurately controlled.) 2. Sensor is damaged 	<ol style="list-style-type: none"> 1. a. Perform sensor heater recalibration; b. Move your sensor bung as far downstream as possible. Right before the cat, or 2-3 feet from the end of the tailpipe are good locations; c. Add a heatsink to isolate the sensor from the pipe. The HBX-1 is an available accessory. 2. Replace sensor.
Error 9	Supply Voltage too low	Supply voltage too low for sensor regulation	Bypass cigarette-adapter, recharge battery, or improve electrical system

Appendix C: Limited Warranty

LIMITED WARRANTY

Innovate stands behind the quality of its products. Innovate makes the following warranty to purchasers of its products: All new Innovate products carry a six-month warranty from the date of purchase. If proof of purchase cannot be provided, warranty will be determined by date of manufacture.

When Warranty Void

This warranty shall terminate and Innovate shall have no obligation pursuant to it if (i) your Innovate product has been modified or repaired in a manner not previously authorized by Innovate in writing, (ii) the identification markings on your Innovate product have been removed, defaced, or altered; (iii) your Innovate product was subjected to accident, abuse, shipping damage, or improper use; (iv) your Innovate product was not used or configured as specified in the product manual; or (v) your Innovate product was subjected to operating conditions more severe than those specified in the product manual.

Exclusions From This Warranty

Oxygen Sensors are excluded from this warranty.

Repairs Under This Warranty

In the unlikely event that your Innovate hardware product should prove defective during the warranty period, contact Innovate Customer Support for a return material authorization (RMA) at 949-502-8400. Products returned for service must be securely packed to prevent damage and shipped charges pre paid, along with proof of purchase and the return material authorization number, to the Innovate repair location as instructed by Customer Service. Innovate within a reasonable amount of time from its receipt of your product so shipped, will ship to you, at its option, the repaired product or a new or reconditioned product of comparable or greater specified functionality. All repaired or replacement products shall be warranted for the remainder of the original product warranty.

Disclaimer

INNOVATE MAKES NO OTHER EXPRESS OR IMPLIED WARRANTY WITH RESPECT TO YOUR INNOVATE PRODUCT OTHER THAN THE LIMITED WARRANTY SET FORTH ABOVE. No Innovate dealer, agent, or employee is authorized to make any modification, extension, or addition to this warranty, unless enforceable or unlawful under applicable law, INNOVATE DISCLAIMS ALL IMPLIED WARRANTIES, INCLUDING THE IMPLIED WARRANTIES OF MERCHANTABILITY, NONINFRINGEMENT, AND FITNESS FOR A PARTICULAR PURPOSE, AND THE LIABILITY OF INNOVATE, IF ANY, FOR DAMAGES RELATING TO ANY ALLEGEDLY DEFECTIVE PRODUCT SHALL UNDER ANY TORT, CONTRACT, OR OTHER LEGAL THEORY BE LIMITED TO THE ACTUAL PRICE PAID FOR SUCH PRODUCT AND SHALL IN NO EVENT INCLUDE INCIDENTAL, CONSEQUENTIAL, SPECIAL, OR INDIRECT DAMAGES OF ANY KIND EVEN IF INNOVATE IS AWARE OF THE POSSIBILITY OF SUCH DAMAGES. Some states do not allow limitations on how long an implied warranty lasts or the exclusion or limitation of incidental or consequential damages, so the above limitations or exclusions may not apply to you.

Revision History

1.0 – 5/12/03

Initial release

1.1- 5/14/03

Corrected misc. errata.

2.0 – 6/15/03

Complete revision and update, incl. sections 6, 9, 10, 11

2.1 – 6/20/03

Corrected misc. errata.

2.2 – 6/21/03

Reformatting of TOC.

2.3 – 6/25/03

Corrected/updated Appendix B

2.4 – 6/26/03

Added Appendix D

2.5 – 7/2/03

Corrected/updated programming section (Section 9).

7.6 - 7/9/03

Updated photos

7.7 - 7/23/03

Update included devices list (Section 2.1).

Added Warning at first page and Installation section (Section 4.1).

Update Analog out programming text and screenshot (Section 9.6).

Update LMD display (Section A.5).

Update Serial Display Section (Section 11.2).

2.8 - 9/03/03

Update copy after the screenshot of the Data Logger Configuration (Section 9.7)

Update photos and copy for Analog Output Cable (Appendix A1)

Update copy for Analog Outputs (Appendix B3)

2.9 - 1/15/04

Corrected section B2- Aux. Input wiring

Corrected various errata

3.0 - 3/30/04

Update section 4.1 and Appendix B

Removed Appendix A

3.1 – 09/23/05

Updated TOC

3.2 – 03/16/06

Added Calibration Schedule